



Luoyang JCB Bearing Technology Company Limited

130.32.1000

SLEWING BEARING

THREE ROW ROLLER SLEWING BEARING





Luoyang JCB Bearing Technology Company Limited

CONTENTS

01.

[MAIN SPECIFICATION](#)

02.

[TECHNICAL INFORMATION](#)

03.

[MANUFACTURE & INSPECTION](#)

04.

[PACKING AND STORAGE](#)

05.

[WARRANTY & CERTIFICATE](#)



Luoyang JCB Bearing Technology Company Limited

130.32.1000

01

MAIN SPECIFICATION

- REFERENCE DRAWING
- SPECIFICATION
- RAW MATERIAL
- LUBRICATIONA
- BOLT HOLES TYPE & BOLTS
- CORROSION PROTECTION



Luoyang JCB Bearing Technology Company Limited

130.32.1000

REFERENCE DRAWING

This drawing is reference for user, if user request for formal drawing , please contact with us: sales@jcb-bearing.com, the official drawing will be submitted to them.

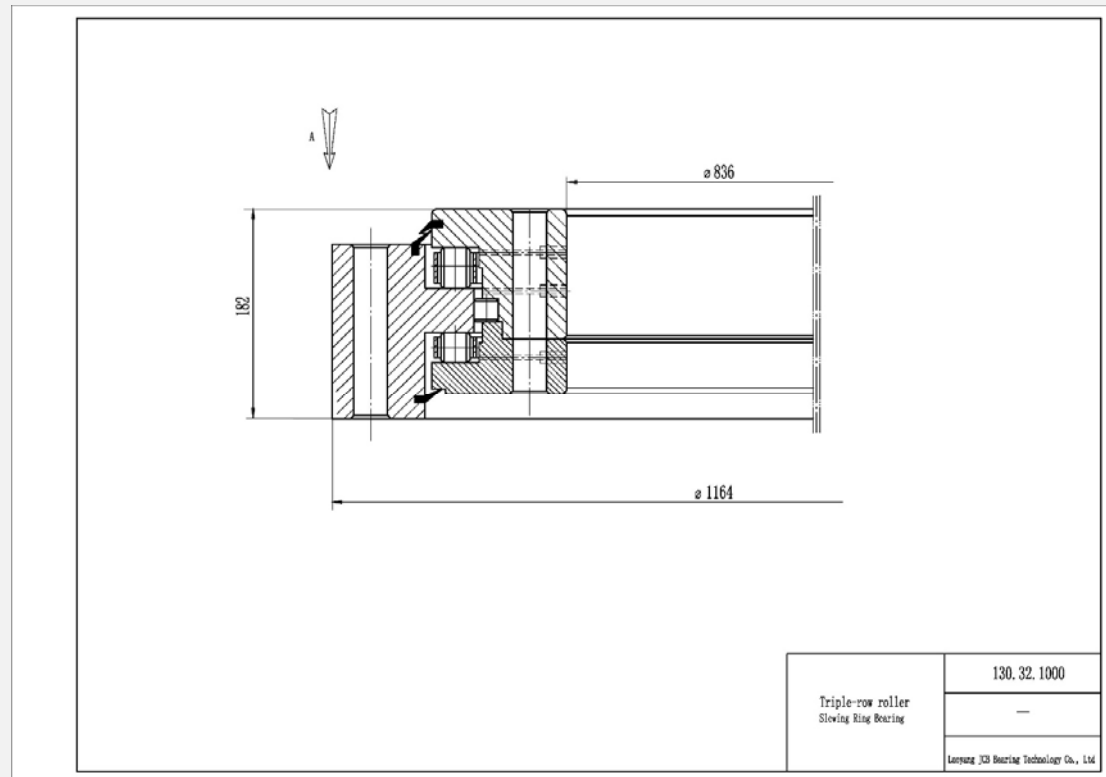

01-1

01-2

Luoyang JCB Bearing Technology Company Limited

SPECIFICATION



130.32.1000

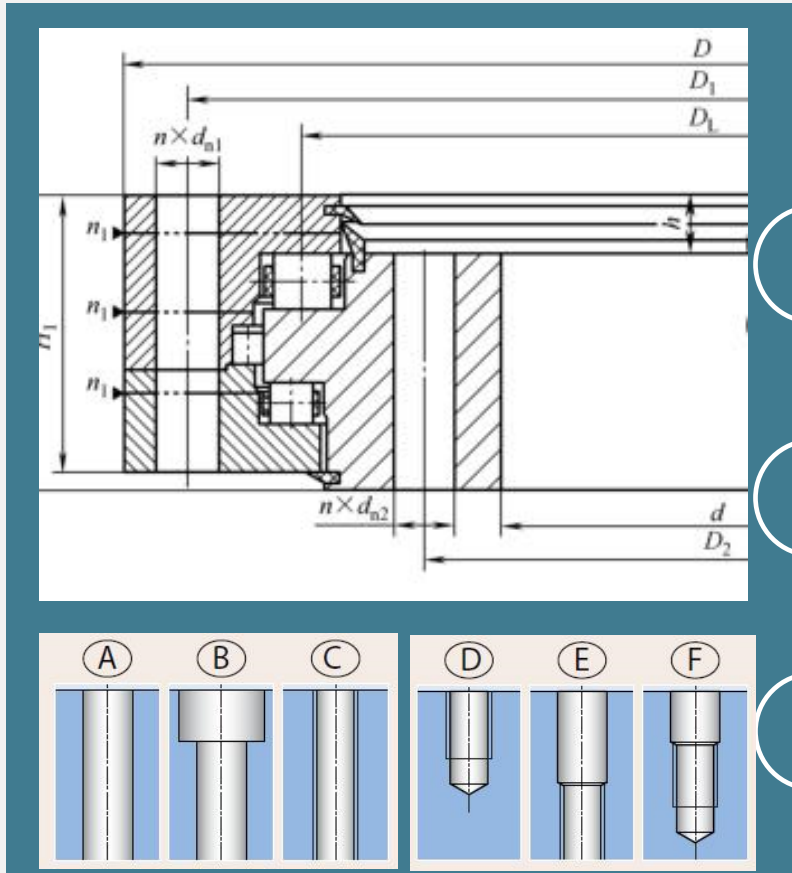

- Inner diameter (d) :836
- Outer diameter (D) :1164
- Overall height (H) :182
- Outer ring height (H1):172
- Inner ring height (H2):142
- Height (h):40
- Weight: 680 KG
- External bolt circle dia (D1) : 1120
- Number of bolt holes per hole circle (n) :40
- External bolt hole type : Selected by user
- External bolt hole diameter(d_{n1}) :22
- Internal bolt circle dia(D2): 880
- Number of bolt holes per hole circle(n):40
- Internal bolt hole type : Selected by user
- Internal bolt hole diameter (d_{n2}) :22