



Luoyang JCB Bearing Technology Company Limited

16387001

SLEWING BEARING

THREE ROW ROLLER SLEWING BEARING





Luoyang JCB Bearing Technology Company Limited

CONTENTS

01.

[MAIN SPECIFICATION](#)

02.

[TECHNICAL INFORMATION](#)

03.

[MANUFACTURE & INSPECTION](#)

04.

[PACKING AND STORAGE](#)

05.

[WARRANTY & CERTIFICATE](#)



Luoyang JCB Bearing Technology Company Limited

16387001

01

MAIN SPECIFICATION

- [REFERENCE DRAWING](#)
- [SPECIFICATION](#)
- [RAW MATERIAL](#)
- [LUBRICATIONA](#)
- [BOLT HOLES TYPE & BOLTS](#)
- [CORROSION PROTECTION](#)



Luoyang JCB Bearing Technology Company Limited

16387001

REFERENCE DRAWING

This drawing is reference for user, if user request for formal drawing , please contact with us: sales@jcb-bearing.com, the official drawing will be submitted to them.

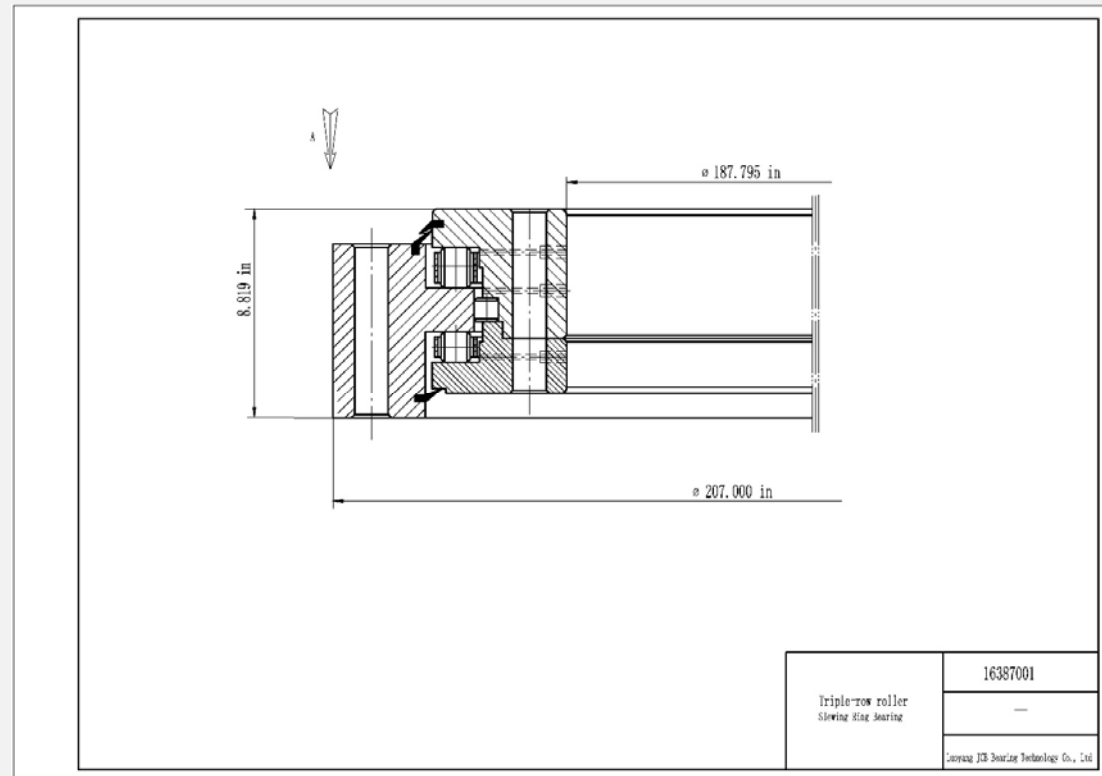

01-1

01-2

Luoyang JCB Bearing Technology Company Limited

SPECIFICATION



16387001

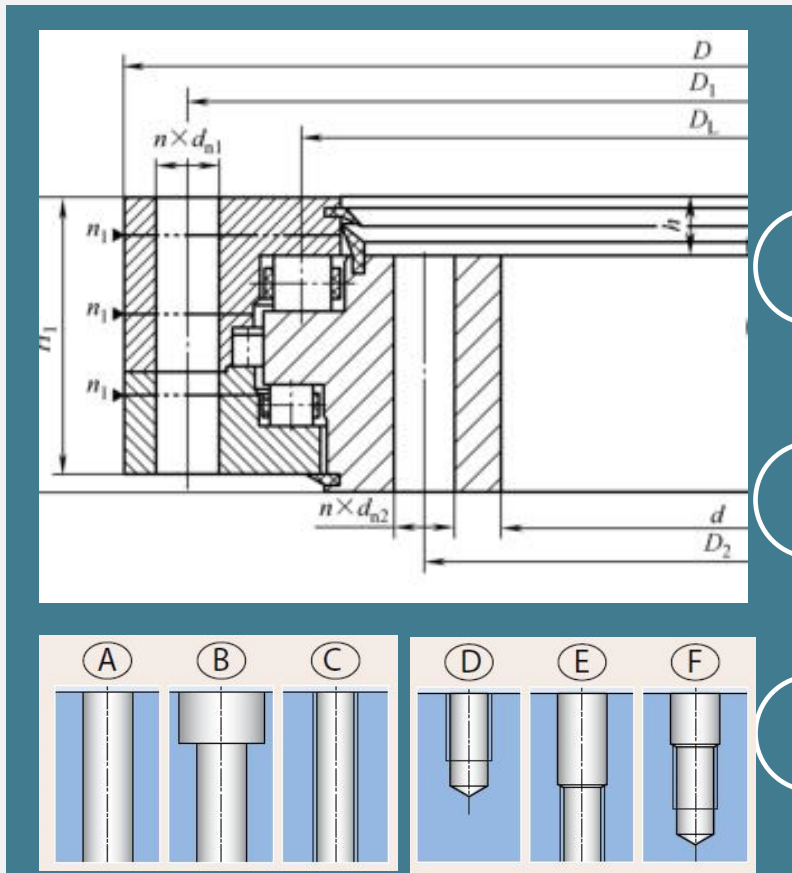

Inner diameter (di): 187.795 in
Outer diameter (Da): 207.000 in
Overall height (H): 8.819 in
Outer ring height (Ho): 8.425 in
Inner ring height (Hi): 8.425 in
Weight: 13200 lbs
External bolt circle dia (Lo): 202.756 in
Number of bolt holes per hole circle (no):120
External bolt hole type : Selected by user
External bolt hole diameter (Bo): 1.535 in
Internal bolt circle dia (Li): 190.945 in
Number of bolt holes per hole circle (ni):120
Internal bolt hole type : Selected by user
Internal bolt hole diameter (Bi): 1.535 in