



Luoyang JCB Bearing Technology Company Limited

3R6-55P9

SLEWING BEARING

THREE ROW ROLLER SLEWING BEARING





Luoyang JCB Bearing Technology Company Limited

CONTENTS

01.

[MAIN SPECIFICATION](#)

02.

[TECHNICAL INFORMATION](#)

03.

[MANUFACTURE & INSPECTION](#)

04.

[PACKING AND STORAGE](#)

05.

[WARRANTY & CERTIFICATE](#)



Luoyang JCB Bearing Technology Company Limited

3R6-55P9

01

MAIN SPECIFICATION

- [REFERENCE DRAWING](#)
- [SPECIFICATION](#)
- [RAW MATERIAL](#)
- [LUBRICATIONA](#)
- [BOLT HOLES TYPE & BOLTS](#)
- [CORROSION PROTECTION](#)



Luoyang JCB Bearing Technology Company Limited

3R6-55P9

REFERENCE DRAWING

This drawing is reference for user, if user request for formal drawing , please contact with us: sales@jcb-bearing.com, the official drawing will be submitted to them.

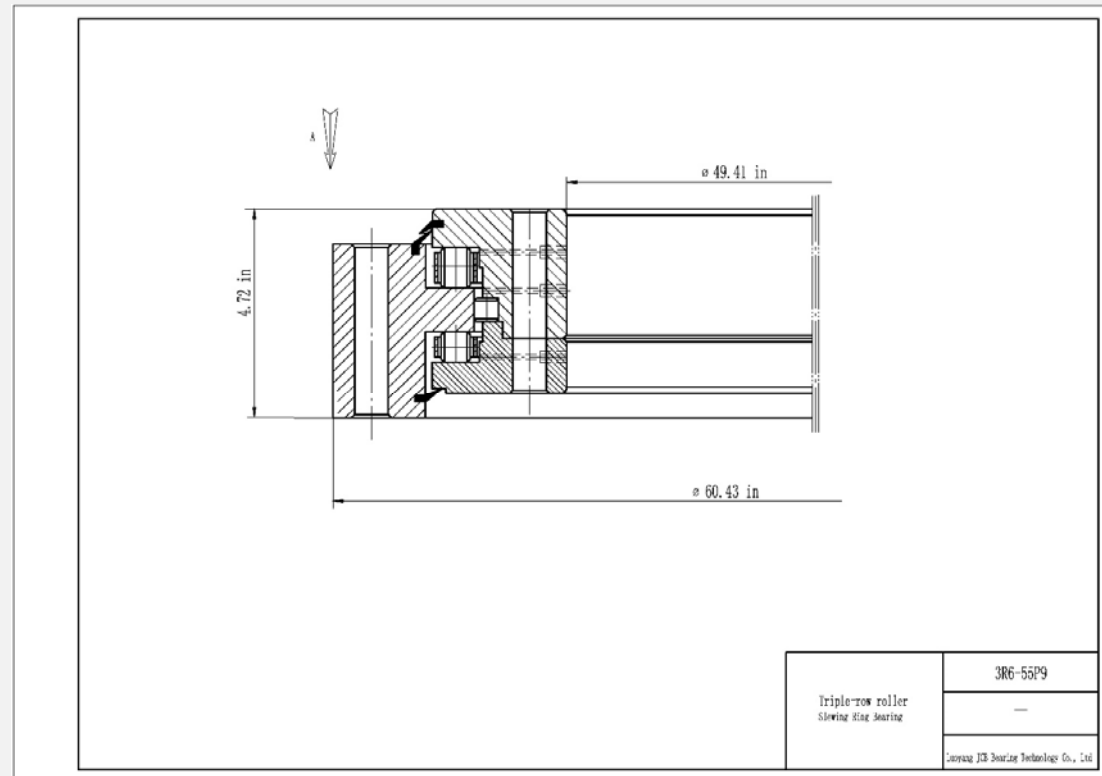

01-2

Luoyang JCB Bearing Technology Company Limited

SPECIFICATION



3R6-55P9

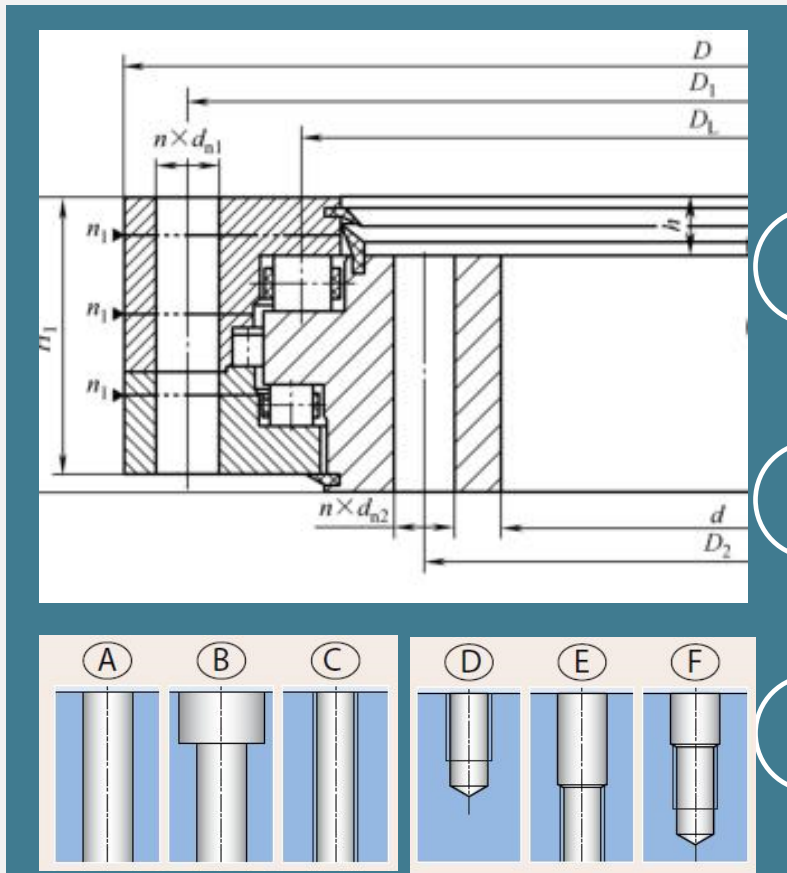

- Inner diameter (di): 49.41 in
- Outer diameter (Da): 60.43 in
- Overall height (H): 4.72 in
- Outer ring height (Ho): 4.41 in
- Inner ring height (Hi): 3.70 in
- Weight: 908 lbs
- External bolt circle dia (Lo): 58.858 in
- Number of bolt holes per hole circle (no):36
- External bolt hole type : Selected by user
- External bolt hole diameter (Bo): 1.02 in
- Internal bolt circle dia (Li): 50.984 in
- Number of bolt holes per hole circle (ni):36
- Internal bolt hole type : Selected by user
- Internal bolt hole diameter (Bi): 1.02 in