



**Luoyang JCB Bearing Technology Company Limited**

**3R6-71P9**

**SLEWING BEARING**

**THREE ROW ROLLER SLEWING BEARING**





# Luoyang JCB Bearing Technology Company Limited

## CONTENTS

01.

[MAIN SPECIFICATION](#)

02.

[TECHNICAL INFORMATION](#)

03.

[MANUFACTURE & INSPECTION](#)

04.

[PACKING AND STORAGE](#)

05.

[WARRANTY & CERTIFICATE](#)



**Luoyang JCB Bearing Technology Company Limited**

**3R6-71P9**

01

## MAIN SPECIFICATION

- [REFERENCE DRAWING](#)
- [SPECIFICATION](#)
- [RAW MATERIAL](#)
- [LUBRICATIONA](#)
- [BOLT HOLES TYPE & BOLTS](#)
- [CORROSION PROTECTION](#)



# Luoyang JCB Bearing Technology Company Limited

## 3R6-71P9

### REFERENCE DRAWING

This drawing is reference for user, if user request for formal drawing , please contact with us: [sales@jcb-bearing.com](mailto:sales@jcb-bearing.com), the official drawing will be submitted to them.

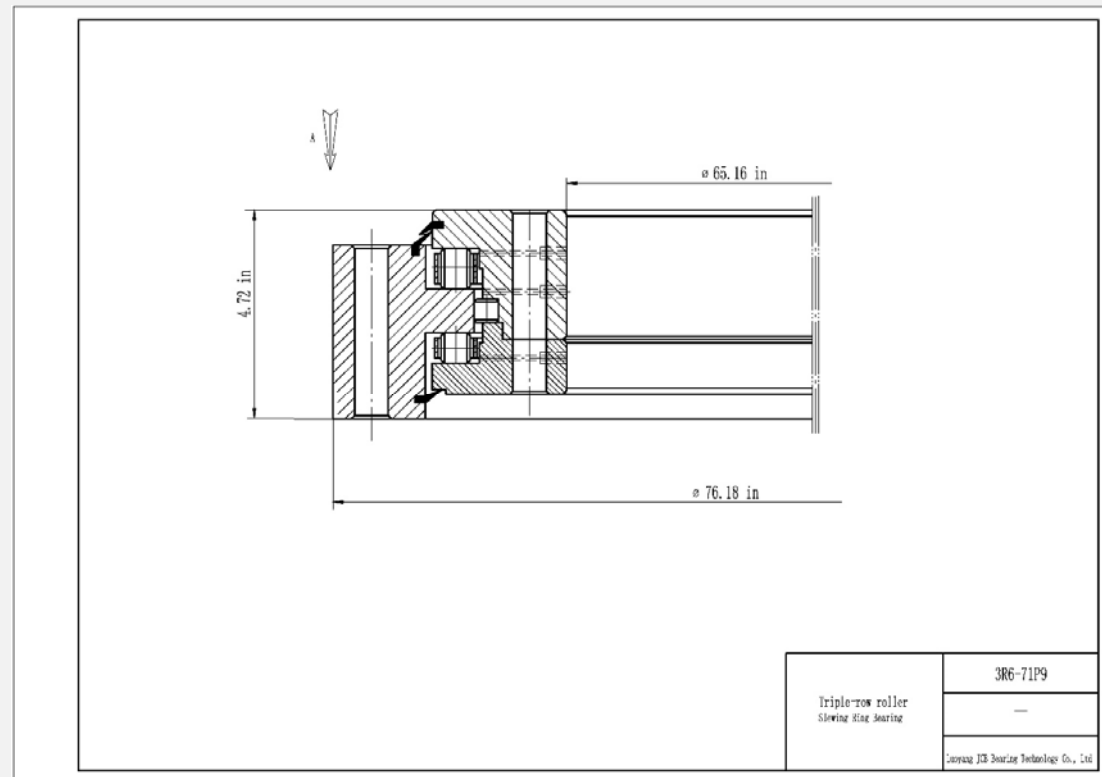

01-2

# Luoyang JCB Bearing Technology Company Limited

## SPECIFICATION



### 3R6-71P9

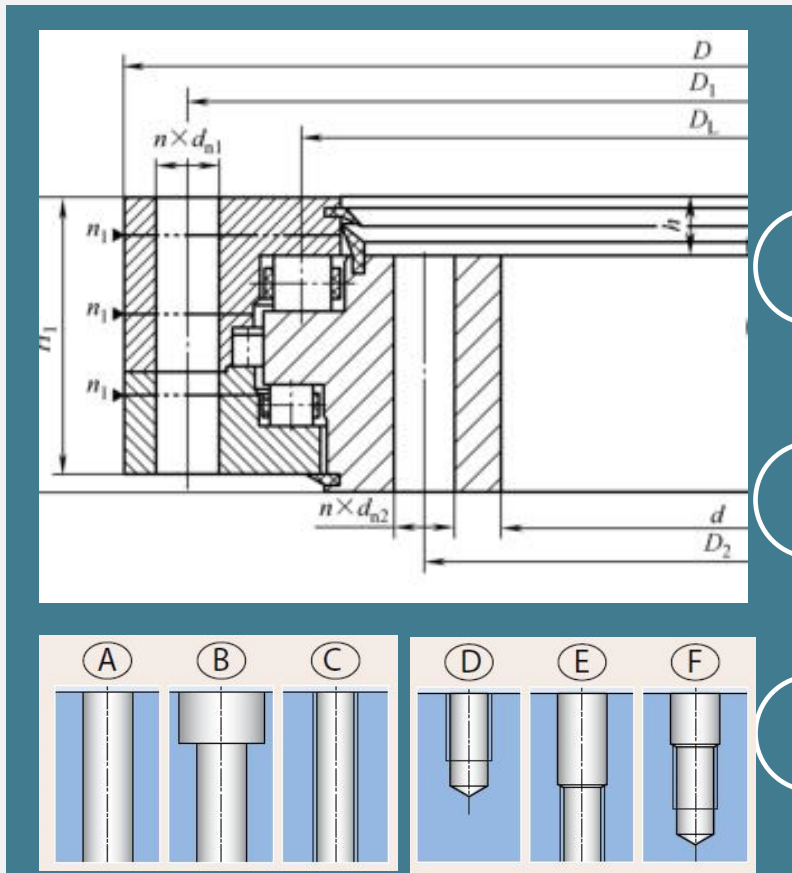

Inner diameter (di): 65.16 in  
Outer diameter (Da): 76.18 in  
Overall height (H): 4.72 in  
Outer ring height (Ho): 4.41 in  
Inner ring height (Hi): 3.70 in  
Weight: 1036 lbs  
External bolt circle dia (Lo): 74.606 in  
Number of bolt holes per hole circle (no):46  
External bolt hole type : Selected by user  
External bolt hole diameter (Bo): 1.02 in  
Internal bolt circle dia (Li): 66.732 in  
Number of bolt holes per hole circle (ni):46  
Internal bolt hole type : Selected by user  
Internal bolt hole diameter (Bi): 1.02 in