



**Luoyang JCB Bearing Technology Company Limited**

**3R8-88P9**

**SLEWING BEARING**

**THREE ROW ROLLER SLEWING BEARING**





# Luoyang JCB Bearing Technology Company Limited

## CONTENTS

01.

[MAIN SPECIFICATION](#)

02.

[TECHNICAL INFORMATION](#)

03.

[MANUFACTURE & INSPECTION](#)

04.

[PACKING AND STORAGE](#)

05.

[WARRANTY & CERTIFICATE](#)



**Luoyang JCB Bearing Technology Company Limited**

**3R8-88P9**

01

## MAIN SPECIFICATION

- [REFERENCE DRAWING](#)
- [SPECIFICATION](#)
- [RAW MATERIAL](#)
- [LUBRICATIONA](#)
- [BOLT HOLES TYPE & BOLTS](#)
- [CORROSION PROTECTION](#)



# Luoyang JCB Bearing Technology Company Limited

## 3R8-88P9

### REFERENCE DRAWING

This drawing is reference for user, if user request for formal drawing , please contact with us: [sales@jcb-bearing.com](mailto:sales@jcb-bearing.com), the official drawing will be submitted to them.

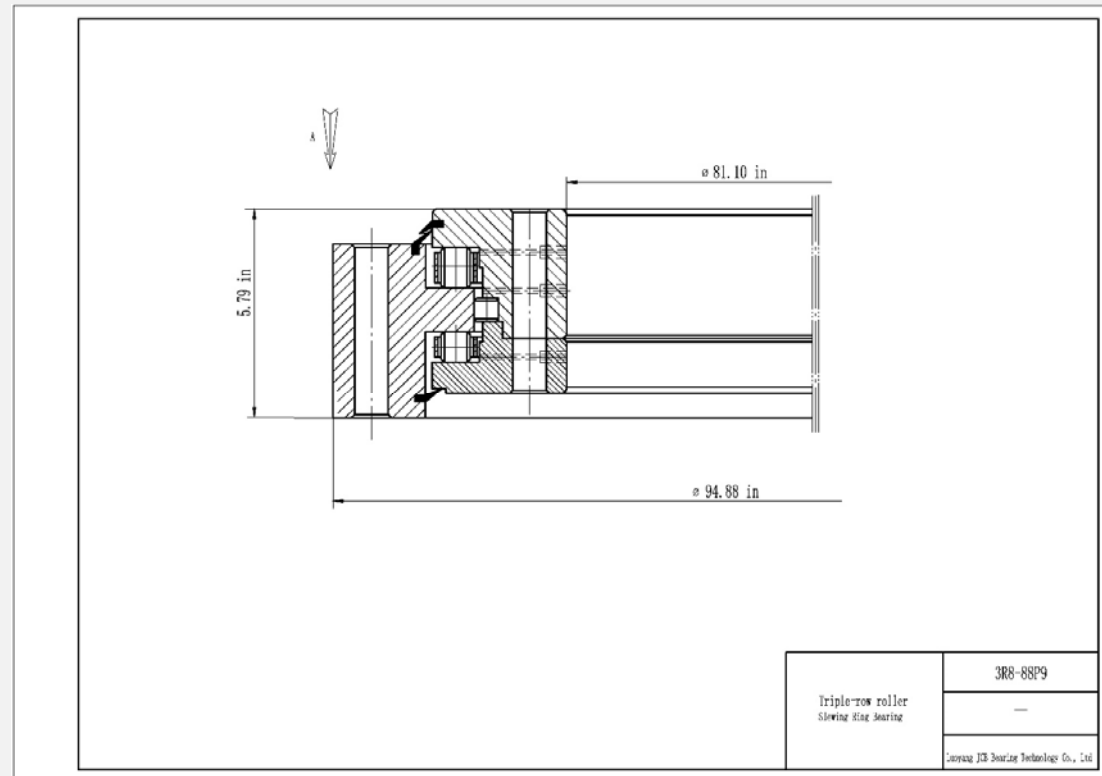

01-2

# Luoyang JCB Bearing Technology Company Limited

## SPECIFICATION



### 3R8-88P9

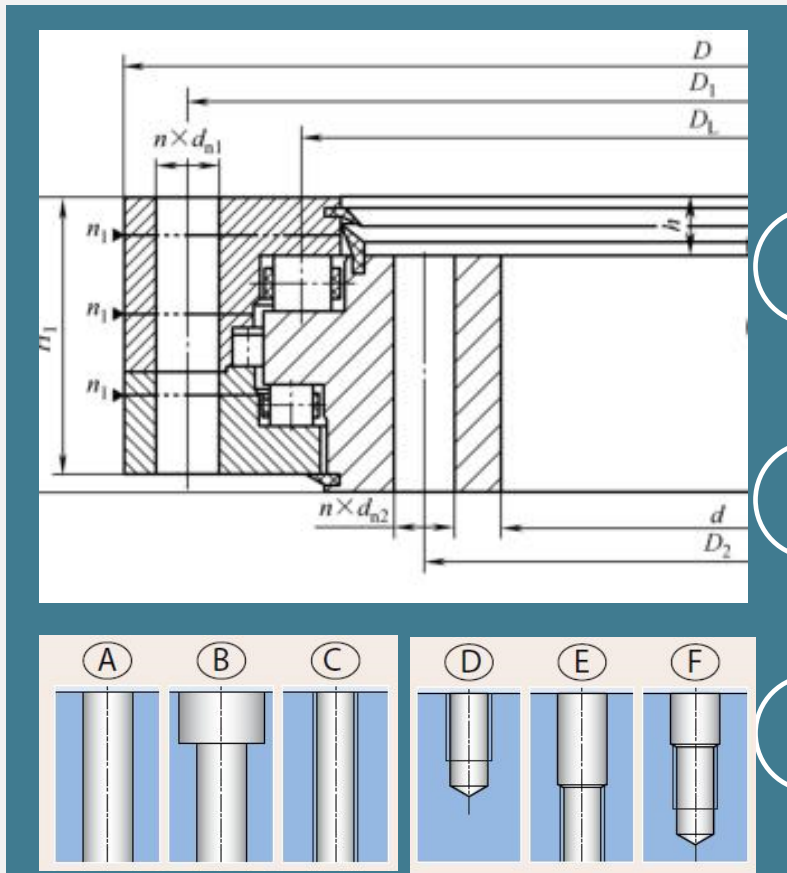

- Inner diameter (di): 81.10 in
- Outer diameter (Da): 94.88 in
- Overall height (H): 5.79 in
- Outer ring height (Ho): 5.43 in
- Inner ring height (Hi): 4.49 in
- Weight: 2249 lbs
- External bolt circle dia (Lo): 92.716 in
- Number of bolt holes per hole circle (no):48
- External bolt hole type : Selected by user
- External bolt hole diameter (Bo): 1.30 in
- Internal bolt circle dia (Li): 83.268 in
- Number of bolt holes per hole circle (ni):48
- Internal bolt hole type : Selected by user
- Internal bolt hole diameter (Bi): 1.30 in